



Front-Loading Automatic Washer

Use & Care Guide

Lavadora automática de carga frontal

Manual de uso y cuidado

Laveuse automatique à chargement frontal

Guide d'utilisation et d'entretien

Models/Modelos/Modèles 796.4027*

* = color number, número de color, numéro de couleur



Designed to use only HE
High Efficiency detergent

Diseñado para utilizar
solamente detergente de alta
eficacia

Conçu pour l'utilisation d'un
détergent haute efficacité
seulement

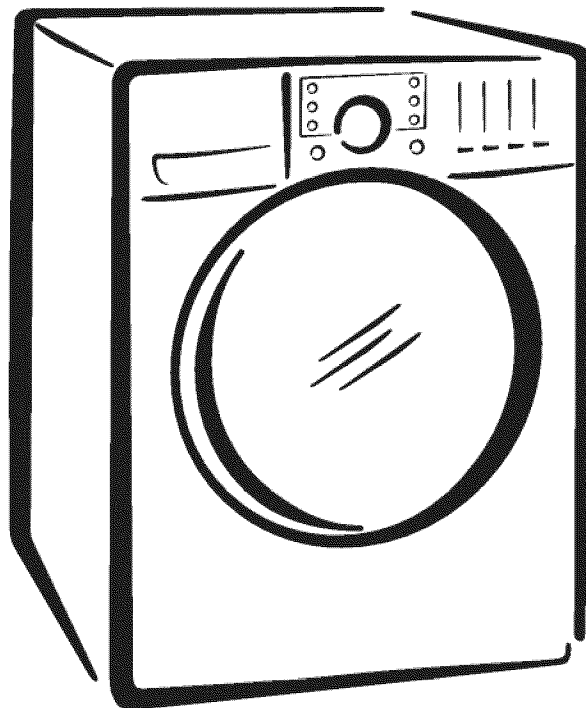

ENGLISH

ESPAÑOL

FRANÇAIS

TABLE OF CONTENTS

SAFETY MESSAGES	3
IMPORTANT SAFETY INSTRUCTIONS	3-5
GROUNDING INSTRUCTIONS.....	5
FEATURES AND BENEFITS	
Key Parts and Components	6
Included Accessories	6
Optional Accessories	6
INSTALLATION REQUIREMENTS	
Key Dimensions and Specifications	7
Choose the Proper Location	7
Flooring	7
Clearances	7
INSTALLATION INSTRUCTIONS	
Unpacking and Removing Shipping Bolts.....	8
Connecting the Water Lines.....	9
Connecting the Drain Hose.....	10
Connect to the Power Supply	10
Leveling the Washer	11
Installation of non-skid pads (optional)	11
HOW TO USE	
Control Panel Features	12
Operating the Washer.....	13
Cycle Guide	14
Sorting Wash Loads.....	15
About the Dispenser	16
Detergent and dispenser use.....	17
Time and Status Display	18
Cycle Modifier Buttons	19
Cycle Option Buttons	20
DELAY START	20
2 nd RINSE.....	20
STAIN TREAT.....	20
AUTO SOAK	20
Special Functions.....	20
CONTROL LOCK.....	20
CLEAN WASHER	20
CARE AND CLEANING	
Regular Cleaning	21-22
Cleaning the Exterior	21
Care and Cleaning of the Interior.....	21
Door Seal and Glass Cleaning.....	21
Removing Mineral Buildup.....	21
Storing the Washer	21
Cleaning the Dispenser.....	22
Maintenance	23-24
Cleaning the Water Inlet Filters.....	23
Cleaning the Drain Pump Filter.....	24
TROUBLESHOOTING GUIDE	
Normal Sounds You May Hear	25
Before Calling for Service	25-28
WARRANTY	29

PRODUCT RECORD

In the space below, record the date of purchase, model, and serial number of your product. You will find the model and serial number printed on an identification plate located inside the washer door. Have these items of information available whenever you contact Sears concerning your product.

Model No. _____

Date of Purchase _____

Serial No. _____

Save these instructions and your sales receipt for future reference.

PROTECTION AGREEMENTS

Master Protection Agreements

Congratulations on making a smart purchase. Your new Kenmore® product is designed and manufactured for years of dependable operation. But like all products, it may require preventive maintenance or repair from time to time. That's when having a Master Protection Agreement can save your money and aggravation.

The Master Protection Agreement also helps extend the life of your new product. Here's what the Agreement* includes:

- **Parts and labor** needed to help keep products operating properly **under normal use**, not just defects. Our coverage goes **well beyond the product warranty**. No deductible, no functional failure excluded from coverage – **real protection**.
- **Expert service** by a force of more than 10,000 authorized **Sears service technicians**, which means someone you can trust will be working on your product.
- **Unlimited service calls and nationwide service**, as often as you want us, whenever you want us.
- **"No-lemon" guarantee** – replacement of your covered product if four or more product failures occur within twelve months.
- **Product replacement** if your covered product can't be fixed.
- **Annual Preventive Maintenance Check** at your request – no extra charge.
- **Fast help by phone** – we call it **Rapid Resolution**. Phone support from a Sears representative on all products. Think of us as a "talking owner's manual."
- **Power surge protection** against electrical damage due to power fluctuations.
- **\$250 food loss protection annually** for any food spoilage that is the result of mechanical failure of any covered refrigerator or freezer.
- **Rental reimbursement** if repair of your covered product takes longer than promised.
- **10% discount** off the regular price of any non-covered repair service and related installed parts

Once you purchase the Agreement, a simple phone call is all that it takes for you to schedule service. You can call anytime day or night or schedule a service appointment online.

The Master Protection Agreement is a risk-free purchase. If you cancel for any reason during the product warranty period, we will provide a full refund, or a prorated refund anytime after the product warranty period expires. Purchase your Master Protection Agreement today!

Some limitations and exclusions apply.

For prices and additional information in the U.S.A. call 1-800-827-6655.

***Coverage in Canada varies on some items.**

For full details call Sears Canada at 1-800-361-6665.

Sears Installation Service

For Sears professional installation of home appliances, garage door openers, water heaters, and other major home items, in the U.S.A. or Canada call 1-800-4-MY-HOME®.

SAFETY MESSAGES

We have provided many important safety messages in this manual and on your appliance. Always read and obey all safety messages.



This is the safety alert symbol.

This symbol alerts you to potential hazards that can result in property damage and/or serious bodily harm or death.

All safety messages will follow the safety alert symbol and either the word DANGER or WARNING. These words mean:

DANGER

Failure to follow these safety instructions may result in property damage and/or serious bodily harm or death.

WARNING

Failure to follow these safety instructions may result in property damage and/or serious bodily harm or death.

All safety messages will tell you what the potential hazard is, tell you how to reduce the chance of injury, and tell you what can happen if the instructions are not followed.

IMPORTANT SAFETY INSTRUCTIONS

WARNING

To reduce the risk of fire, electric shock, or injury to persons when using this appliance, follow basic precautions, including the following.

- Before use, the washer must be properly installed as described in this manual.
- Do not wash articles that have been previously cleaned in, washed in, soaked in, or spotted with gasoline, dry cleaning solvents, or other flammable or explosive substances, as they give off vapors that could ignite or explode.
- Do not add gasoline, dry cleaning solvents, or other flammable or explosive substances to the wash water. These substances give off vapors that could ignite or explode.
- Under certain conditions, hydrogen gas may be produced in a hot water system that has not been used for 2 weeks or more. **HYDROGEN GAS IS EXPLOSIVE.** If the hot water system has not been used for such a period, before using the washer, turn on all hot water faucets and let the water flow from each for several minutes. This will release any accumulated hydrogen gas. As the gas is flammable, do not smoke or use an open flame during this time.
- Do not allow children to play on or in the washer. Close supervision of children is necessary when the washer is used near children.
- Before the washer is removed from service or discarded, remove the door to prevent children from climbing inside.
- Do not install or store the washer where it will be exposed to the weather or freezing temperatures.
- Do not tamper with controls.
- Do not repair or replace any part of the washer or attempt any servicing other than as described in this manual. We strongly recommend that any service be performed by a qualified individual.
- See Installation Instructions for grounding requirements.
- **ALWAYS** follow the fabric care instructions supplied by the garment manufacturer.
- Do not place items exposed to cooking oil in your washer. Items contaminated with cooking oils may contribute to a chemical reaction that could cause a load to catch fire.
- Use fabric softeners or products to eliminate static only as recommended by the manufacturer.
- This washer is not designed for maritime use or for mobile installations such as in RVs, aircraft, etc.
- Turn off the water taps and unplug the washer if the machine is to be left for an extended period of time, such as during vacations.
- Packaging material can be dangerous for children. There is a risk of suffocation! Keep all packaging from children.
- Always check the inside of the washer for foreign objects before loading laundry. Keep the door closed when not in use.

IMPORTANT SAFETY INSTRUCTIONS

WARNING

To reduce the risk of fire, electric shock, or injury to persons when using this appliance, follow basic precautions, including the following.

- **Unplug the washer before cleaning** to avoid the risk of electric shock.
- **Never use harsh chemicals, abrasive cleaners, or solvents to clean the washer.** They will damage the finish.
- **Do not put oily or greasy rags or clothing on top of the washer.** These substances give off vapors that could ignite the materials.
- **Do not wash items that are soiled with vegetable or cooking oil.** These items may contain some oil after laundering and may catch fire.
- **Disconnect this appliance from the power supply before attempting any user maintenance. Turning the controls to the OFF position does not disconnect this appliance from the power supply.** Failure to follow this warning can cause serious injury, fire, electrical shock, or death.
- **Do not combine detergents, fabric softeners, and other laundry products from different manufacturers for use in one load unless specified on the label.**
- **Do not mix chlorine bleach with ammonia or acids such as vinegar. Follow package directions when using laundry products.** Incorrect usage can produce poisonous gas, resulting in serious injury or death.
- **Do not reach into the washer while parts are moving. Before loading, unloading, or adding items, push in the cycle selector knob and allow the drum to coast to a complete stop before reaching inside.** Failure to follow this warning can cause serious injury, fire, electrical shock, or death.

WARNING

- **Refer to INSTALLATION INSTRUCTIONS for detailed grounding procedures.** Installation instructions are packed in the washer for installer's reference. If the washer is moved to a new location, have it checked and reinstalled by a qualified service person. Failure to follow this warning can cause serious injury, fire, electrical shock, or death.
- **Do not, under any circumstances, cut or remove the third (ground) prong from the power cord.** Failure to follow this warning can cause serious injury, fire, electrical shock, or death.
- **For personal safety, this appliance must be properly grounded.** Failure to follow this warning can cause serious injury, fire, electrical shock, or death.
- **The power cord of this appliance is equipped with a 3-prong (grounding) plug which mates with a standard 3-prong (grounding) wall outlet** to minimize the possibility of electric shock hazard from this appliance.
- **This washer must be plugged into a 120VAC, 60Hz grounded outlet.** Failure to follow this warning can cause serious injury, fire, electrical shock, or death.
- **Have the wall outlet and circuit checked by a qualified electrician to make sure the outlet is properly grounded.** Failure to follow this warning can cause serious injury, fire, electrical shock, or death.
- **Where a standard 2-prong wall outlet is encountered, it is your personal responsibility and obligation to have it replaced with a properly grounded 3-prong wall outlet.** Failure to follow this warning can cause serious injury, fire, electrical shock, or death.
- **Do not install on carpet. Install washer on a solid floor.** Failure to follow this warning can cause serious leak damage.
- **Do not remove grounding prong. Do not use an adapter or extension cord. Plug into a grounded 3-prong outlet.** Failure to follow these warnings can cause serious injury, fire, electrical shock, or death.
- **The washer should always be plugged into its own individual electrical outlet which has a voltage rating that matches the rating plate.** This provides the best performance and also prevents overloading house wiring circuits which could cause a fire hazard from overheated wires.
- **Never unplug your washer by pulling on the power cord.** Always grip plug firmly and pull straight out from the outlet. Failure to follow this warning can cause serious injury, fire, electrical shock, or death.
- **Immediately repair or replace all power cords that have become frayed or otherwise damaged. Do not use a cord that shows cracks or abrasion damage along its length or at either end.** Consult with a qualified service person. Failure to follow this warning can cause serious injury, fire, electrical shock, or death.
- **When installing or moving the washer, be careful not to pinch, crush, or damage the power cord.** Failure to follow this warning can cause serious injury, fire, electrical shock, or death.
- **The washer must be installed and electrically grounded by a qualified service person in accordance with local codes** to prevent shock hazard and assure stability during operation.
- **Washer is heavy. Two or more people may be needed to install and move the appliance.** Failure to do so can result in back or other injury.
- **Store and install the washer where it will not be exposed to temperatures below freezing or exposed to outdoor weather conditions.** Failure to follow this warning can cause serious leak damage.
- **To reduce the risk of electric shock, do not install the washer in humid spaces.** Failure to follow this warning can cause serious injury, fire, electrical shock, or death.

IMPORTANT SAFETY INSTRUCTIONS

⚠ WARNING: RISK TO CHILDREN

- **Do not allow children to play on or in the washer. Close supervision of children is necessary when the washer is used near children. As children grow, teach them the proper, safe use of all appliances.** Failure to comply with these warnings could result in serious personal injuries.
- **Destroy the carton, plastic bag, and other packing materials after the washer is unpacked. Children might use them for play. Cartons covered with rugs, bedspreads, or plastic sheets can become airtight chambers.** Failure to comply with these warnings could result in serious personal injuries.
- **Keep laundry products out of children's reach. To prevent personal injury, observe all warnings on product labels.** Failure to comply with these warnings could result in serious personal injuries.
- **Remove the door to the washing compartment to avoid the danger of children or small animals getting trapped inside before your washer is removed from service or discarded.** Failure to do so can result in serious personal injury or death.

GROUNDING REQUIREMENTS

**IMPORTANT: Please read carefully.
TO CONNECT ELECTRICITY**

⚠ WARNING

Improper connection of the equipment-grounding conductor can result in risk of electric shock. Check with a qualified electrician or serviceman if you are in doubt as to whether the appliance is properly grounded. Do not modify the plug provided with the appliance. If it does not fit the outlet, have a proper outlet installed by a qualified electrician. Failure to follow these warnings can cause serious injury, fire, electrical shock, or death.

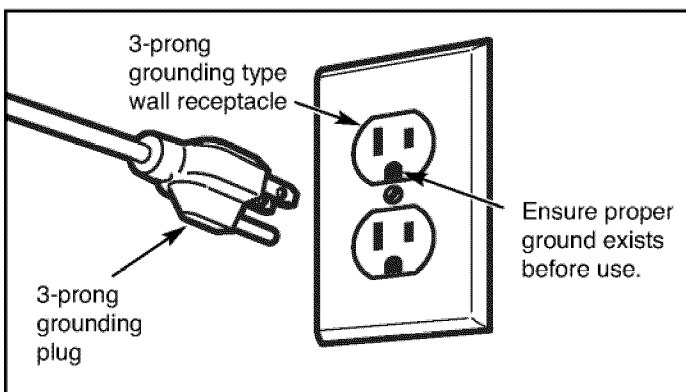

GROUNDING INSTRUCTIONS

This appliance must be grounded. In the event of malfunction or breakdown, grounding will reduce the risk of electric shock by providing a path of least resistance for electric current. This appliance is equipped with a cord having an equipment-grounding conductor and grounding plug. The plug must be plugged into an appropriate outlet that is properly installed and grounded in accordance with all local codes and ordinances.

FEATURES AND BENEFITS

KEY PARTS AND COMPONENTS

A DETERGENT DISPENSER

There are four compartments, one each for prewash (not used on this model) main wash, liquid bleach, and liquid fabric softener.

B CONTROL PANEL WITH LED DISPLAY

The easy-to-read LED display shows cycle options, settings, cycle status, and estimated time remaining during operation.

NOTE: Sensors in the washer automatically detect the size of the wash load to optimize washing time, based on the selected cycle and options.

C DIRECT-DRIVE MOTOR

The direct-drive motor provides improved performance and reliability while increasing energy efficiency. (Motor is not visible.)

D LARGE-CAPACITY STAINLESS STEEL DRUM

The ultra-large stainless steel drum offers extreme durability and is tilted to improve efficiency and allow easier access for large items.

E EASY-ACCESS LOCKING DOOR

The extra-large door locks during operation and has a delay feature to prevent the door from being opened until it is safe to do so.

F FILTER ACCESS PANEL

Provides easy access to the drain pump filter, which allows you to clean the filter or retrieve lost items without a service call.

G LEVELING FEET

Four leveling feet (two in the front and two in the back) adjust to improve washer stability on uneven floors. Feet are adjusted and locked in place using the adjusting wrench included with the washer.

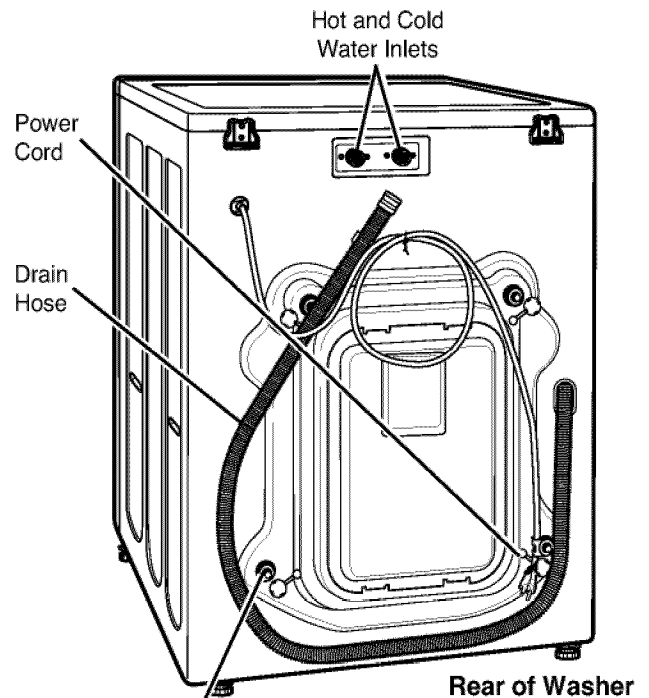
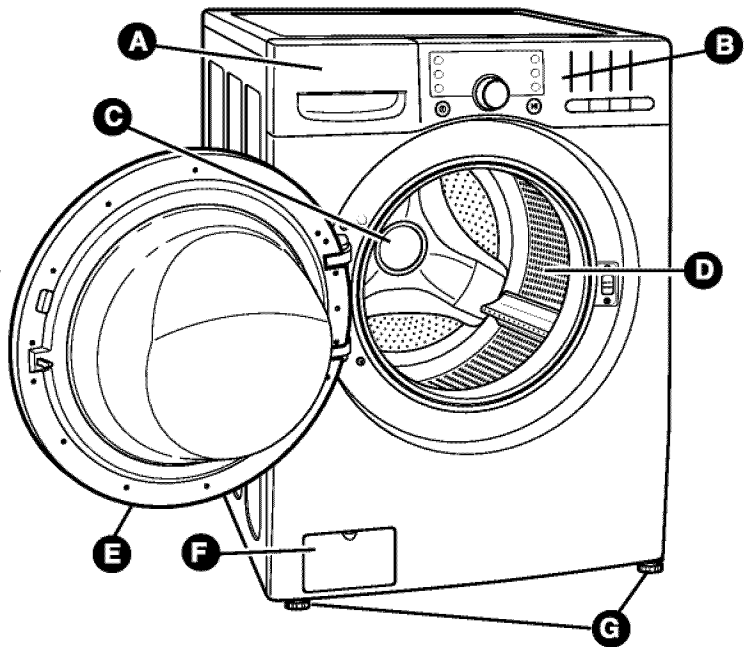

Shipping Bolts/Retainers (4)
NOTE: Bolts/retainers **MUST** be removed prior to operation. Keep for future use. See page 8.

Included Accessories

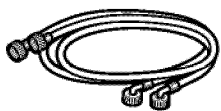

Hot and Cold Water Hoses



Non-skid pads

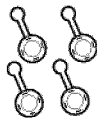

Caps (4)
(for covering shipping bolt holes)



Wrench (for removing shipping bolts and adjusting and locking leveling feet)



Tie Strap
(for securing drain hose)

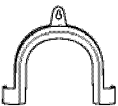

Elbow Bracket
(for securing drain hose)

Optional Accessories

Drain Hose Extension



P/N 5215ER2002K

Stacking kit (For dryer)



D26 17002 (White)
 D26 17008 (Ginger)
 D26 17009 (Chili Pepper)

INSTALLATION REQUIREMENTS

KEY DIMENSIONS AND SPECIFICATIONS

Description	Front-Loading Washer
Rated Voltage/Frequency	120 VAC @ 60 Hz.
Dimensions	27" (W) X 29 ³ / ₄ " (D) X 38 ¹¹ / ₁₆ " (H), 51 ¹ / ₈ " (D, door open) 68.6 cm (W) X 75.6 cm(D) X 98.3 cm(H), 129.8 cm (D, door open)
Net Weight	190 lb. (86 kg)

CHOOSE THE PROPER LOCATION

⚠ WARNING

- **Washer is heavy! Two or more people are required when moving and unpacking the washer.** Failure to do so may result in damage to property or serious bodily harm.
- **Store and install the washer where it will not be exposed to temperatures below freezing or exposed to outdoor weather conditions.** Failure to follow this warning can cause serious injury, fire, electrical shock, or death.
- **Properly ground washer to conform with all governing codes and ordinances.** Failure to follow this warning can cause serious injury, fire, electrical shock, or death.
- **To reduce the risk of electric shock, do not install the washer in humid spaces.** Failure to follow this warning can cause serious injury, fire, electrical shock, or death.
- The base opening must not be obstructed by carpeting when the washer is installed on a carpeted floor.
- **Do not remove ground prong. Do not use an adapter or extension cord. Plug into a grounded 3-prong outlet.** Failure to follow this warning can cause serious injury, fire, electrical shock, or death.

Power Outlet

- The power outlet must be within 60 in. (1.5 m) of either side of the washer.
- The appliance and outlet must be positioned so that the plug is easily accessible.
- Do not overload the outlet with more than one appliance.
- The outlet must be grounded in accordance with current wiring codes and regulations.
- Time-delay fuse or circuit breaker is recommended.

NOTE: It is the personal responsibility and obligation of the product owner to have a proper outlet installed by a qualified service person.

FLOORING

- To minimize noise and vibration, the washer **MUST** be installed on a solidly constructed floor. See the NOTE at right.
- Allowable slope under the entire washer is a maximum 1" difference from side to side or from front to back.
- Carpeting and soft tile surfaces are not recommended.
- Never install the washer on a platform or weakly supported structure.

CLEARANCES

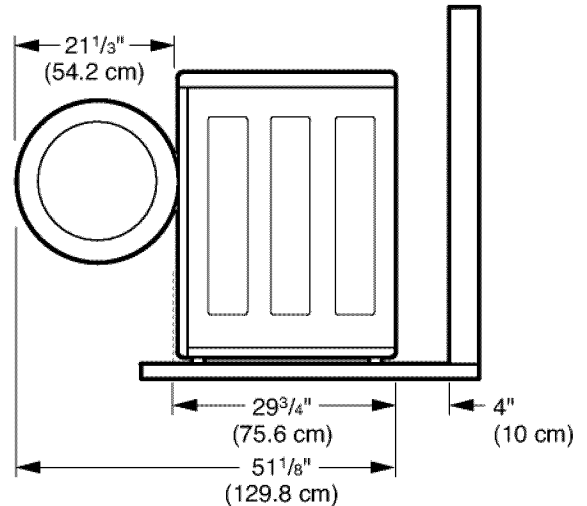

To ensure sufficient clearance for water lines and airflow, allow minimum clearances of at least 1 in. (2.5 cm) at the sides and 4 in. (10 cm) behind the unit. Be sure to allow for wall, door, or floor moldings that may increase the required clearances.

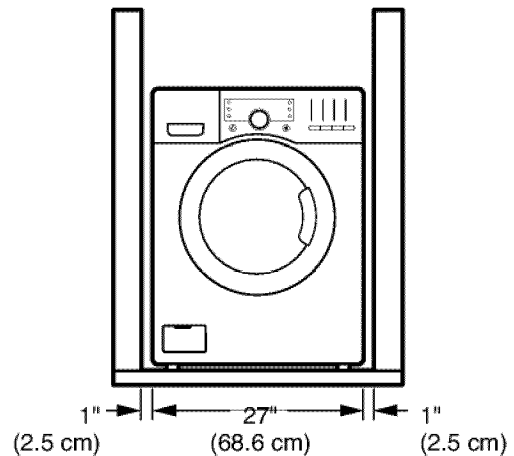

Allow at least 21¹/₄ in. (54 cm) in front of the washer to open the door.

NOTE: Please note that the floor must be strong and rigid enough to support the weight of the washer, when fully loaded, without flexing or bouncing. If your floor has too much flex in it, you may need to reinforce it to make it more rigid. A floor that is adequate for a top-loading washer may not be rigid enough for a front loading washer, due to the difference in the spin speed and direction. If the floor is not solid, your washer may vibrate and you may hear and feel the vibration throughout your house.

INSTALLATION INSTRUCTIONS

UNPACKING AND REMOVING SHIPPING BOLTS

When removing the washer from the carton base, be sure to remove the foam tub support in the middle of the carton base. See drawing below.

If you must lay the washer down to remove the base packaging materials, always protect the side of the washer and lay it carefully on its side. **DO NOT** lay the washer on its front or back.

To prevent internal damage during transport, the washer is equipped with 4 shipping bolts and plastic retainers.

IMPORTANT:

- These shipping bolts and retainers **MUST NOT** be removed until just before moving the washer into its final position.
- These bolts and retainers **MUST** be removed before operating the washer.
- Failure to remove shipping bolts and retainers may cause severe vibration and noise, which can lead to permanent damage to the washer.

NOTE: The cord is secured to the back of the washer with a shipping bolt to help prevent operation with shipping bolts in place.

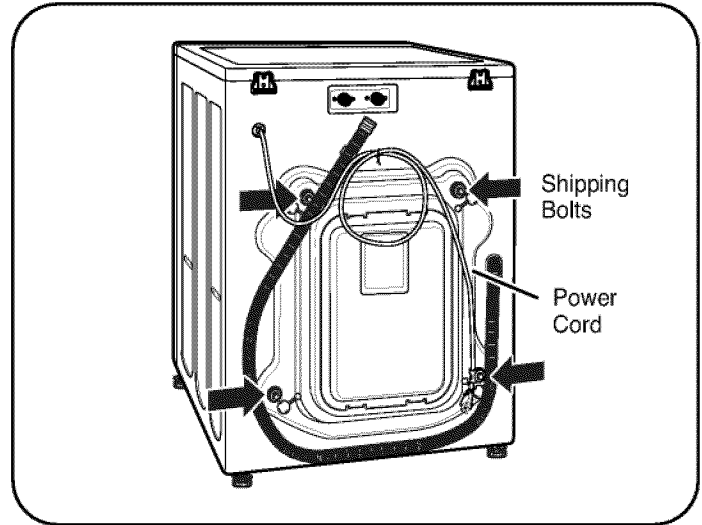
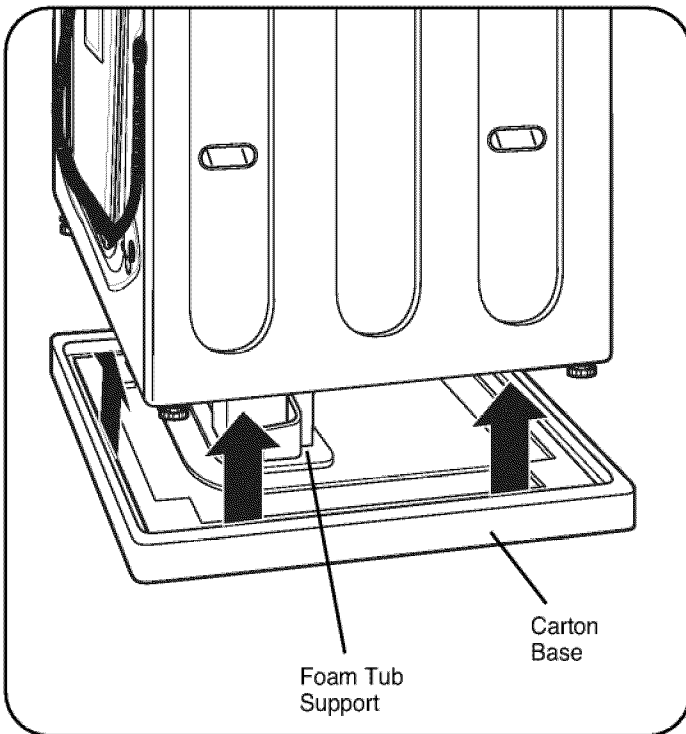

1. Starting with the bottom 2 shipping bolts, use the included wrench to fully loosen the 4 shipping bolts by turning them counterclockwise.

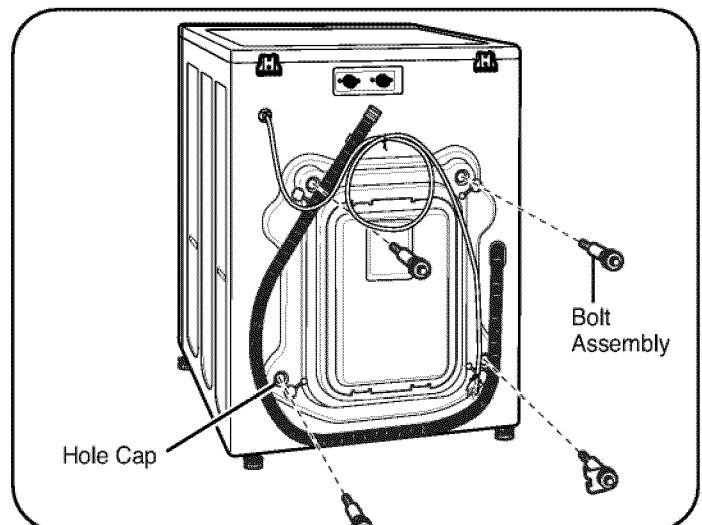

2. Remove the bolt assemblies by wiggling them slightly while pulling.
3. Locate the four hole caps included in the accessory pack and install them in the shipping bolt holes.

NOTE: Save the bolt assemblies for future use. To prevent damage to internal components, the bolt assemblies must be installed when transporting the washer.

INSTALLATION INSTRUCTIONS

CONNECTING THE WATER LINES

- **IMPORTANT:** Use new hoses when installing the washer. Do NOT reuse old hoses.
- **IMPORTANT:** Use ONLY the inlet hoses provided with this laundry product. Aftermarket hoses are not guaranteed to fit or function correctly. Other hoses may not tighten correctly and could cause leaks. Subsequent damage to product or property will not be covered under the terms of the product warranty.
- Water supply pressure must be between 14.5 PSI and 116 PSI (100~800 kPa). If the water supply pressure is more than 116 PSI, a pressure reducing valve must be installed.
- Periodically check the hose for cracks, leaks, and wear, and replace the hose if necessary.
- Make sure that the water lines are not stretched, pinched, crushed, or kinked.
- The washer should never be installed or stored in a location subject to freezing temperatures. Damage to the water lines and internal mechanisms of the washer can result. If the washer was exposed to freezing temperatures prior to installation, allow it to stand at room temperature for several hours before use and check for leaks prior to operation.

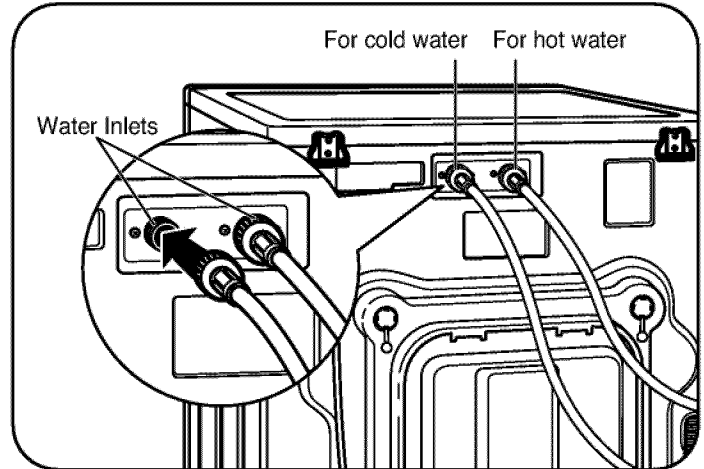

2. Attach the red, hot water line to the hot water inlet on the back of the washer. Attach the blue, cold water line to the cold water inlet on the back of the washer. Tighten the fittings securely.

NOTE: Be careful not to cross-thread the hose fittings since this will damage the valve and could result in property damage from leaks.

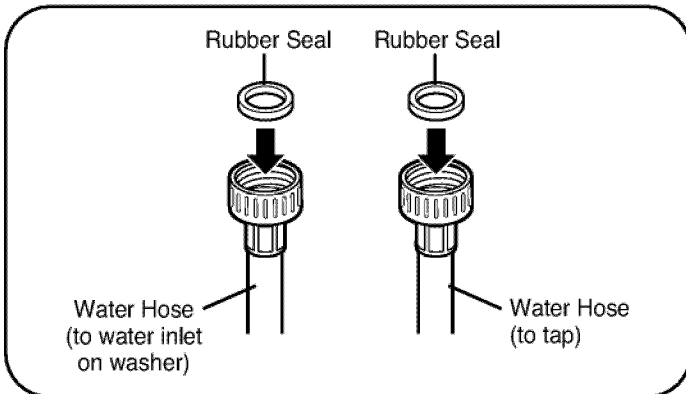

1. Inspect the threaded fitting on each hose and make sure there is a rubber seal in place in both ends.

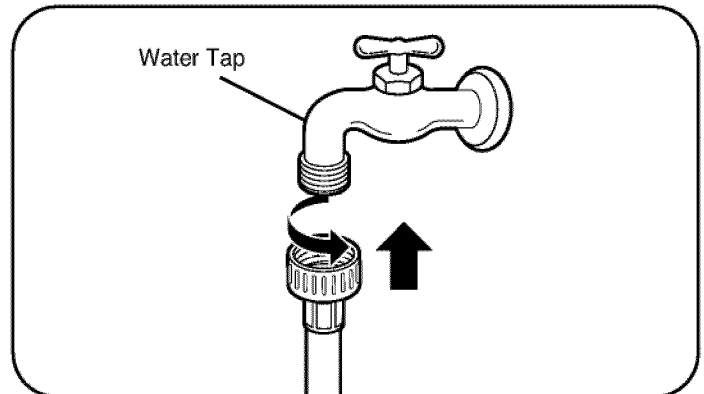

3. Connect the water supply hoses to the HOT and COLD water faucets tightly by hand and then tighten another 2/3 turn with pliers. Turn on the water faucets and check for leaks.

INSTALLATION INSTRUCTIONS

CONNECTING THE DRAIN HOSE

- The drain hose should always be properly secured. Failure to properly secure the drain hose can result in flooding and property damage.
- Do not install the end of the drain hose higher than 96 in. (244.8 cm) above the bottom of the washer.
- The drain must be installed in accordance with any applicable local codes and regulations.
- Make sure that the drain hose is not stretched, pinched, crushed, or kinked.

NOTE:

A drain hose extension kit is available if the drain hose is not long enough. Do not extend drain hose more than 6 feet, as this will cause poor draining resulting in poor wash and spin performance.

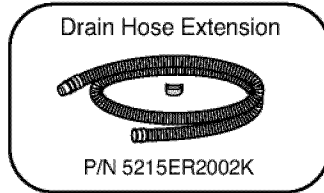

Option 1: Standpipe

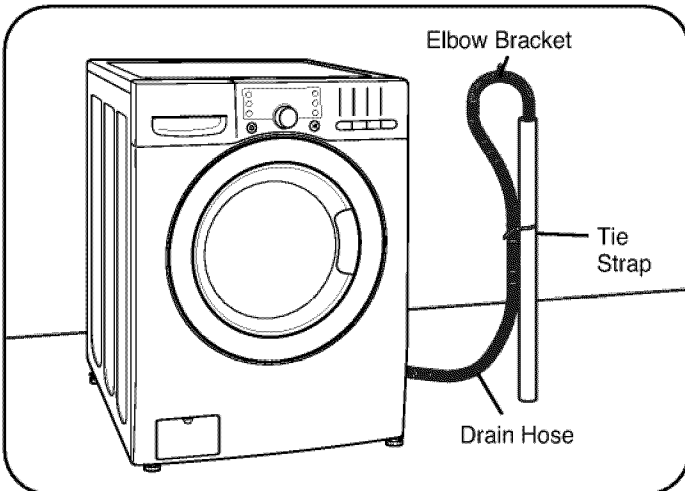

The elbow bracket should be installed near the end of the drain hose. Insert the end of the drain hose into the standpipe. Use tie strap to secure the drain hose in place.

NOTE:

- Total height of the hose end should not exceed 96 in. (244.8 cm) from the bottom of the washer.
- The drain hose should be inserted no more than 8–12 inches into the standpipe.

NOTE: If the drain hose is extended more than 4 inches beyond the end of the end of the elbow bracket, mold, or microorganisms could spread to the inside of the washer.

Option 2: Laundry Tub

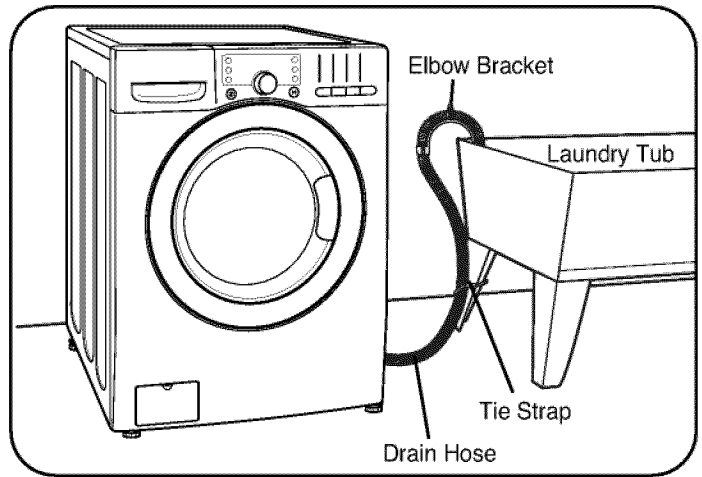

The elbow bracket should be installed near the end of the drain hose. Hang the end of the drain hose over the side of the laundry tub. Use tie strap to secure the drain hose in place.

Option 3: Floor Drain

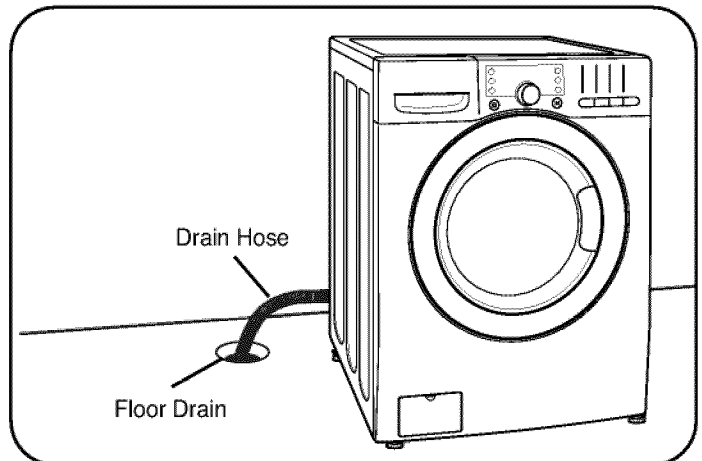

Insert the end of the drain hose into the floor drain. Secure the hose to prevent it from moving.

CONNECT TO POWER SUPPLY

Washer should be plugged into a 120-VAC, 60-Hz. grounded 3-prong outlet.

Plug in the washer.

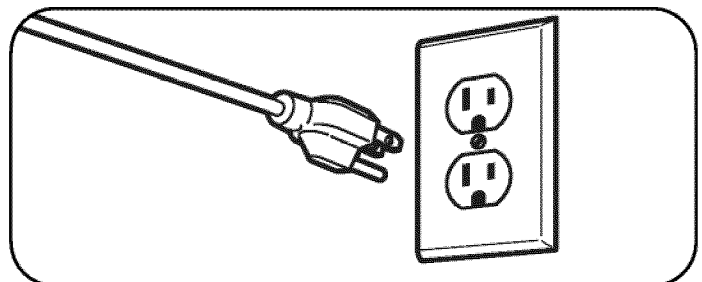

INSTALLATION INSTRUCTIONS

LEVELING THE WASHER

The drum of your new washer spins at very high speeds. To minimize vibration, noise, and unwanted movement, the floor must be a level, solid surface.

NOTE: Adjust the leveling feet only as far as necessary to level the washer. Extending the leveling feet more than necessary can cause the washer to vibrate.

NOTE: Before installing the washer, make sure the floor is clean, dry and free of dust, dirt, water and oils so the washer feet can not slide easily. Leveling feet that can move or slide on the floor can contribute to excess vibration and noise due to poor contact with the floor. See **INSTALLATION OF NON-SKID PADS** below for more information.

NOTE: If a drip pan must be used, take extra care to follow the instructions provided with the drip pan and make sure the leveling feet are adjusted for firm and even contact with the pan. Use of drip pans and failure to properly level the machine may result in increased vibration and noise during operation.

- All four leveling feet must rest solidly on the floor. Attempt to rock the washer from corner to corner to make sure that all four leveling feet are in firm contact with the floor.

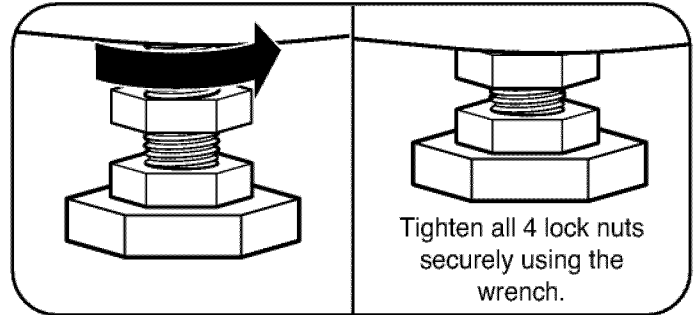
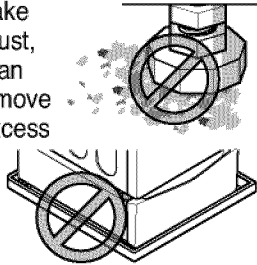

3. Once the washer is level from side to side and front to back, use the adjusting wrench to tighten all four lock nuts securely to prevent the legs from getting out of adjustment during operation. Make sure that all 4 leveling feet are in firm contact with the floor.

NOTE: To make sure that the washer is properly level, run the washer with a test load: place a medium-sized load of laundry in the machine. Then press **POWER**, select **RINSE+SPIN**, and then press the **START/PAUSE** button. See the following sections for additional information on cycle selection and operation. Verify that the washer does not rock or vibrate excessively during the spin cycle. If the washer vibrates or shakes, adjust the leveling feet, while the washer is spinning, until the vibrations are reduced to a minimum.

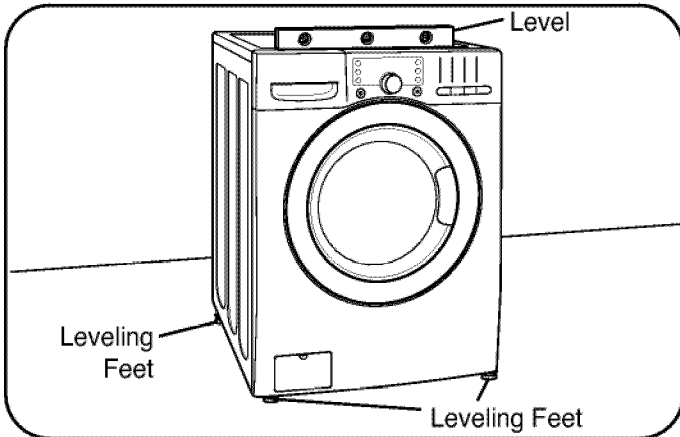

1. Position the washer in the final location, taking special care to not pinch, strain, or crush the water and drain lines. Place a level across the top of the washer.

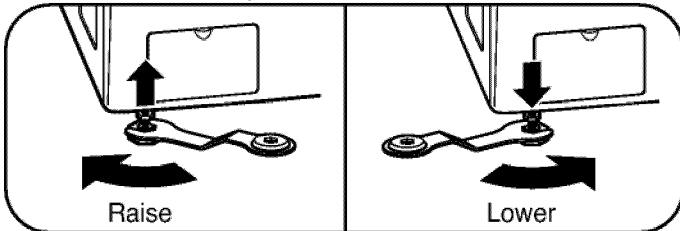

2. Loosen locknuts using the wrench on all 4 leveling feet until you can turn the feet with the included wrench. Turning the leveling foot clockwise lowers the foot and raises the washer; turning the foot counterclockwise raises the foot and lowers the washer. Raise or lower the leveling feet until the washer is level from side to side and front to back. Make sure that all 4 leveling feet are in firm contact with the floor. Use a level when adjusting the feet to make sure the washer is level.

NOTE: If you are installing the washer on the optional pedestal, the washer leveling feet should be fully retracted. Use the leveling feet on the pedestal to level the washer.

INSTALLATION OF NON-SKID PADS (optional)

Some floor surfaces are too slippery to prevent the washer from moving on the floor during heavily unbalanced loads. While it is normal for an occasional load to be out of balance, excess noise and vibration can result from the washer moving out of position. If these conditions are encountered, follow the instructions below for installation of the non-skid pads. These pads will help prevent the washer from moving during heavy out of balance conditions thereby reducing noise and vibration.

Non-skid pads

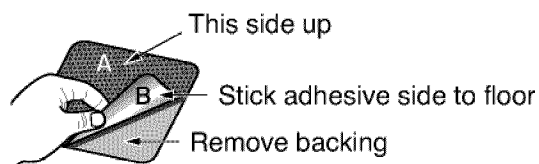

- * Place the pads under both front feet.

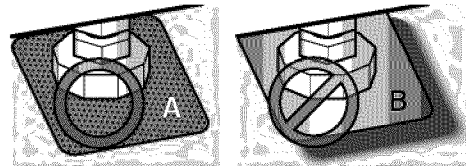

HOW TO USE

WARNING: To reduce the risk of fire, electric shock, or injury to persons, read and follow this entire manual, including the Important Safety Instructions, before operating this washer.

CONTROL PANEL FEATURES

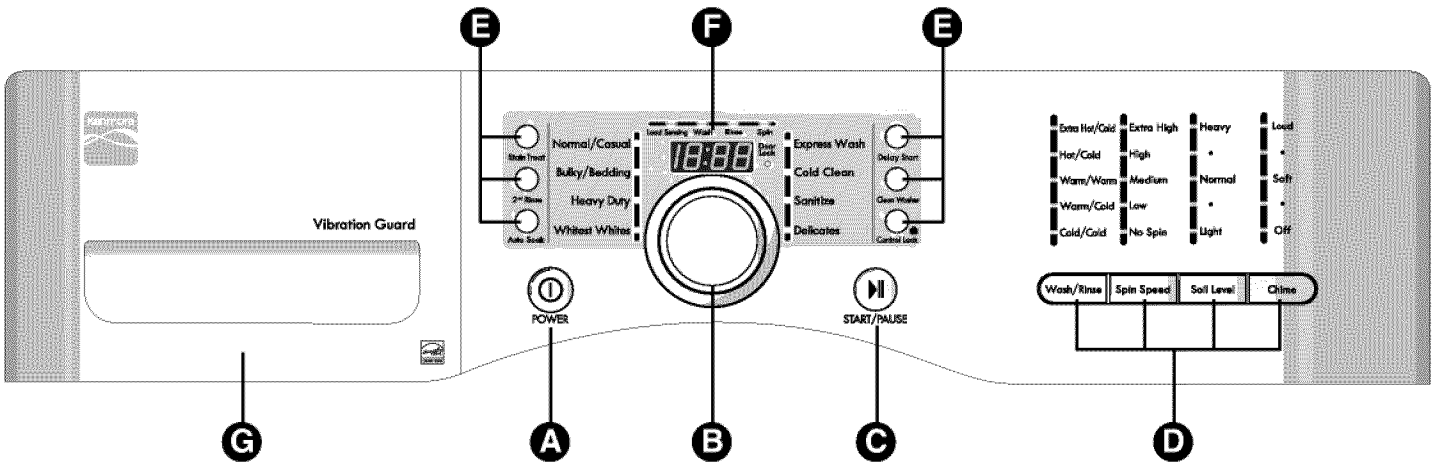

A POWER (ON/OFF) BUTTON

Press to turn the washer ON. Press again to turn the washer OFF.

NOTE: Pressing the POWER button during a cycle will cancel that cycle and any load settings will be lost. The door will unlock after a brief pause unless the water level or temperature is too high.

B CYCLE SELECTOR KNOB

Turn this knob to select the desired cycle. Once the desired cycle has been selected, the standard presets will be shown in the display. These settings can be adjusted using the cycle setting buttons anytime before starting the cycle. (See the cycle guide on page 14 for allowable settings. To protect your fabrics, not all settings are allowed in all cycles.)

C START/PAUSE BUTTON

Press this button to start the selected cycle. If the washer is running, use this button to pause the cycle without losing the current settings.

NOTE : If you do not press the START/PAUSE button within 4 minutes of selecting a cycle, the washer automatically turns off.

D CYCLE MODIFIER BUTTONS

Use these buttons to adjust the desired cycle options for the selected cycle. The lights above the buttons show the current selection. See page 19 for a complete description.

NOTE : Not all settings are available on all cycle selections. See chart on page 14 for details.

E SPECIAL CYCLE AND OPTION BUTTONS

These buttons are used to activate special cycles or options. See page 20 for details.

F TIME AND STATUS DISPLAY

The display shows the estimated time remaining, load size, cycle status, and door lock status. See page 18 for a complete description.

G DISPENSER

Dispenser drawer. This drawer contains the compartments for detergent and additives. See pages 16 -17 for complete information.

HOW TO USE

OPERATING THE WASHER

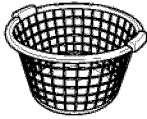

1 SORT LAUNDRY AND LOAD WASHER

Refer to page 15.

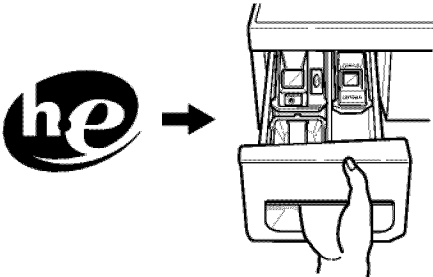

2 ADD DETERGENT AND OTHER PRODUCTS

Open the dispenser drawer and add **he** detergent to the main wash compartment in the dispenser drawer. Add bleach and fabric softener as desired. See pages 16 and 17 for important information on detergents and dispenser use.

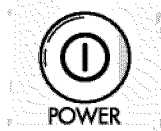

3 TURN ON THE WASHER

Press the POWER button to turn on the washer. The lights around the Cycle Selector Knob will illuminate and a chime will sound, if turned on. Refer to page 12.

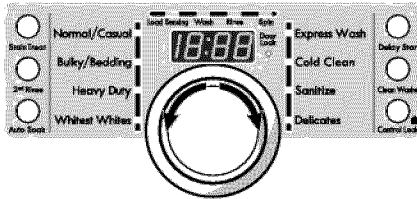

4 SELECT A CYCLE

Turn the Cycle Selector Knob either direction to select the desired cycle. The preset Wash/Rinse Temperature, Spin Speed, Soil Level, and Option settings for that cycle will be shown. Refer to page 12.

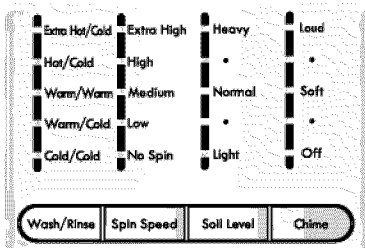

5 SELECT CYCLE MODIFIERS

Default settings for the selected cycle can now be changed if desired. This can be done using the cycle modifier buttons as shown on page 19 (Wash/Rinse, Spin Speed, Soil Level, and Chime).

NOTE: To protect your fabrics, not all modifiers are available on all cycles.

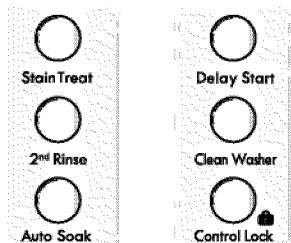

6 SELECT CYCLE OPTIONS

Cycle options can also be added using the options buttons as shown on page 20 (Stain Treat, 2nd Rinse, Control Lock, and Delay Start).

NOTE: Not all options are available on all cycles.



7 BEGIN CYCLE

Press the START/PAUSE button to begin the cycle. Once the cycle has been started, pressing the START/PAUSE again will pause the washer and retain the existing settings for up to 4 minutes.

























HOW TO USE

CYCLE GUIDE

The cycle guide below shows the default settings, available options and recommended fabric types for each cycle. Allowable modifier adjustments are shown below the default setting for each cycle.

 = Available option

 = Default setting

Cycle				Modifiers			Options		
Cycle	Fabric or Load Type	Cycle Time	Wash Motion	Wash/Rinse Temperature	Spin Speed	Soil Level	AUTO SOAK	2 nd RINSE	STAIN TREAT
Normal/Casual	Cotton, linen, towels, shirts, sheets, jeans, mixed loads	52		Warm/Cold	High	Normal			
				Warm/Warm Hot/Cold Cold/Cold	Extra High No Spin Low Medium	Heavy Light			
Bulky/Bedding	Large items such as blankets and comforters	59		Warm/Cold	Low	Normal			
				Warm/Warm Hot/Cold Cold/Cold	Medium No Spin	Heavy Light			
Heavy Duty	Heavy soiled Cotton Fabrics	80		Warm/Cold	Extra High	Heavy			
				Warm/Warm Hot/Cold Cold/Cold	No Spin Low Medium High	Light Normal			
Whitest Whites	White Fabrics	75		Hot/Cold	High	Normal			
				Cold/Cold Warm/Cold Warm/Warm	Extra High No Spin Low Medium	Heavy Light			
Express Wash	Lightly soiled clothing and small loads	20		Hot/Cold	Extra High	Light			
				Cold/Cold Warm/Cold Warm/Warm	No Spin Low Medium High	Normal Heavy			
Cold Clean	Small loads of cotton, linen, towels, shirts, sheets, jeans, mixed loads	63		Cold/Cold	High	Normal			
					Extra High No Spin Low Medium	Light			
Sanitize	Heavily soiled items, such as work clothes, diapers, etc.	107		Extra Hot/Cold	High	Normal			
					Extra High No Spin Low Medium	Heavy Light			
Delicates	Dress shirts/blouses nylons, sheer or lacy garments	42		Cold/Cold	Medium	Normal			
				Warm/Cold Warm/Warm	No Spin Low	Heavy Light			

NOTE: To protect your garments, not every wash/rinse temperature, spin speed, soil level, or option is available with every cycle.

 **NOTE:** These cycles use various wash motions to enhance cleaning and/or fabric care performance. These wash motions may sound different at different stages of the wash cycle. This is normal.

SORTING WASH LOADS

Fabric Care Labels

Many articles of clothing include a fabric care label. Using the chart below, adjust the cycle and options selections to care for your clothing according to the manufacturer's recommendations.

Fabric Care Labels

Machine wash cycle

Normal Permanent press/wrinkle resistant Gentle/delicate

Hand wash Do not wash Do not wring

Water temperature

Hot (50°C/120°F) Warm (40°C/105°F) Cold/cool (30°C/85°F)

Bleach symbols

Any bleach (when needed) Only non-chlorine bleach (when needed) Do not bleach

Grouping Similar Items

For the best washing results and to reduce the possibility of damage to the clothing, care should be taken to sort the clothing into loads that are made up of similar items. Mixing different fabric types and/or soil levels can poor wash performance, color transfer or discoloration, fabric damage or linting. Fabrics should be sorted into groups as described below.

Colors

Sort articles by color. Wash dark clothes together in a separate load from light colors or whites. Mixing dark clothes with light clothes can result in dye transfer or discoloration of the lighter clothes.

Soil Level

Wash heavily soiled clothes together. Washing lightly soiled clothes in the same load with heavily soiled clothes could result in poor wash performance for the lightly soiled clothing.

Fabric Type

Delicate articles should not be mixed with heavier or sturdier fabric types. Washing delicates in a load with heavy fabrics can result in damage to the more delicate fabrics. Washing heavier fabrics in a delicate load can result in poor wash performance for the heavier fabrics and possible damage to the delicates.

Lint Type

Some fabrics attract and bind lint to them while others give off lint in the laundry process. Avoid mixing these lint collectors and lint producers in the same load. Mixing these fabrics will result in pilling and linting on the lint collectors. (For example, lint collector – knit sweater; lint producer – terrycloth towels)

Loading the Washer

- **Check all pockets to make sure that they are empty.** Items such as clips, matchboxes, pens, coins, and keys can damage both your washer and your clothes.
- Close zippers, hooks, and drawstrings to prevent these items from snagging or tangling on other clothes.
- Pretreat heavily stained areas for best results.
- Combine large and small items in a load. Load large items first.
- Large items should not be more than half of the total wash load.
- The washer can be fully loaded, but the drum should not be tightly packed with items. The door of the washer should close easily.
- To prevent an out-of-balance load, do not wash single items. Add one or two similar items to the load. Large, bulky items, such as a blanket, comforter, or bedspread, should be washed individually.
- Do not wash or spin waterproof items, such as rain coats, sleeping bags, etc.
- When unloading the washer, check under the door seal for small items.

NOTE: Make sure the door seal area is clear when closing the door. Overloading the washer can cause items to get caught between the door and the seal. This can damage both the items and the seal.



**DO NOT OVERLOAD THE DRUM
MAKE SURE CLOTHING IS NOT
CAUGHT IN THE DOOR GASKET**

Sort Laundry...

by Colors	by Soil	by Fabric	by Lint
Whites	Heavy	Delicates	Lint Producer
Lights	Normal	Easy Care	Lint Collector
Darks	Light	Study	

ABOUT THE DISPENSER

The automatic dispenser consists of four compartments which hold:

- Liquid chlorine bleach.
- Liquid fabric softener.
- Liquid or powdered detergent for prewash. (This compartment is not used on this model.)
- Liquid or powdered detergent and color-safe bleach for main wash.

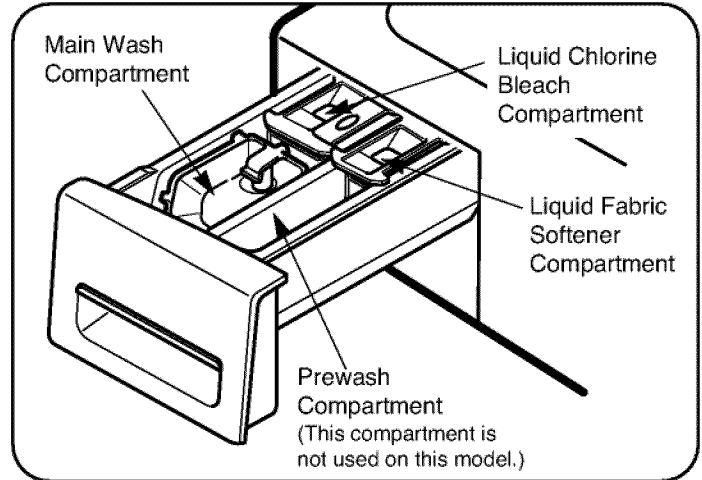

ENGLISH

Pre-Wash Detergent Compartment

The dispenser drawer has a compartment that is labeled "Prewash". However, this model does not include a prewash option. Do not put detergent in this compartment. Detergent in this compartment will not be dispensed and will need to be manually cleaned out. See Maintenance on page 23.

Main Wash Detergent Compartment

This compartment holds laundry detergent for the main wash cycle; this detergent is added to the load at the beginning of the cycle. Always use HE (High-Efficiency) detergent with your washing machine. Either powdered or liquid detergent may be used.

Never exceed the manufacturer's recommendations when adding detergent. Using too much detergent can result in detergent buildup in clothing and the washer.

NOTE: Liquid or powdered color-safe bleach may be added to the main wash compartment with detergent of the same type. **DO NOT** add liquid or powdered color-safe bleach to the bleach dispenser. **DO NOT** mix liquid and powdered cleaning agents within the same compartment.

Liquid Bleach Compartment

This compartment holds liquid chlorine bleach, which will be dispensed automatically at the proper time during the wash cycle.

- Do not add powdered or liquid color-safe bleach to this compartment. The bleach compartment is designed to dispense liquid chlorine bleach only. Powdered or liquid color-safe bleach will not dispense properly.
- Always follow the manufacturer's recommendations when adding bleach. Do not exceed the maximum fill line since this can cause the bleach to be dispensed immediately causing damage to fabrics. Using too much bleach can damage fabrics.
- Never pour undiluted liquid chlorine bleach directly onto the load or into the drum. Fabric damage can occur.

Fabric Softener Compartment

This compartment holds liquid fabric softener, which will be automatically dispensed during the final rinse cycle.

Never exceed the manufacturer's recommendations when adding softener. Using too much fabric softener can result in buildup in clothing and the washer. Either powdered or liquid fabric softener may be used.

- Always follow the manufacturer's recommendations when adding fabric softener. Do not exceed the maximum fill line. Using too much fabric softener may stain clothes.
- Dilute concentrated fabric softeners with warm water. Do not exceed the maximum fill line.
- Never pour fabric softener directly onto the load or into the drum.

DETERGENT AND DISPENSER USE

A Word About Detergents

HE detergents produce fewer suds, dissolve more efficiently to improve washing and rinsing performance, and help to keep the interior of your washer clean.

Using non-HE detergent may cause oversudsing and unsatisfactory performance which could result in error codes, cycle failure, and machine damage.

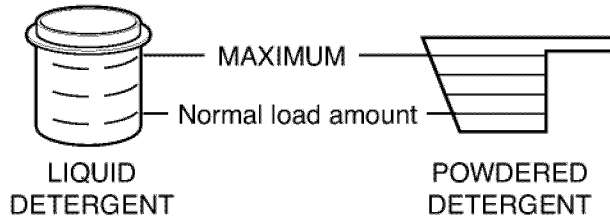

For proper wash performance, always measure the detergent using the measure provided with the detergent by the manufacturer.

The normal amount needed for average loads is less than 1/2 of the recommended maximum. **Use less detergent** for soft water, light soil or smaller loads. **Never** use more than the maximum amount recommended by the detergent manufacturer.



**Designed to use only
HE (High-Efficiency) detergent**

IMPORTANT: Your washing machine is designed for use with only High-Efficiency (HE) detergents. HE detergents are formulated specifically for front-load washers and contain suds-reducing agents. Always look for the HE symbol when purchasing detergent.

IMPORTANT: Not all detergents are the same. Careful attention must be paid to the amount of detergent used to avoid overusing, poor rinsing and detergent buildup in clothing, and residue buildup that can contribute to odors in the machine. **NEVER** use a cup or scoop other than that supplied by the manufacturer of the detergent you are using. Never use more than the maximum amount recommended by the manufacturer of the detergent.

While HE detergents are designed for this type of washing machine, care must be used when measuring the detergent. For most normal loads, no more than 1/2 to 3/4 of a cup or scoop of HE detergent should be used.

NOTE: Extra care must be exercised when using **2X** and **3X** concentrated detergents because even a little bit extra can contribute to the problems mentioned above.

NOTE: Detergents designated as HE-COMPATIBLE may not provide optimal results.

Filling the Dispenser

To add detergent, bleach, and fabric softener to the automatic dispenser:

- 1 Open the dispenser lid.
- 2 Load the laundry products into the appropriate compartments.
- 3 Close the lid before starting the cycle.

NOTE: It is normal for a small amount of water to remain in the bleach and softener compartments at the end of the cycle.

IMPORTANT: Do not place or store laundry products, such as detergent, bleach, or liquid fabric softener, on top of your washer or dryer. Wipe up any spills immediately. These products can damage the finish and controls.

NOTE: Do not put detergent or other laundry products in the Prewash compartment. This compartment is not used on this model

TIME AND STATUS DISPLAY

The time and status display shows the estimated time remaining, cycle progress, and door lock status.

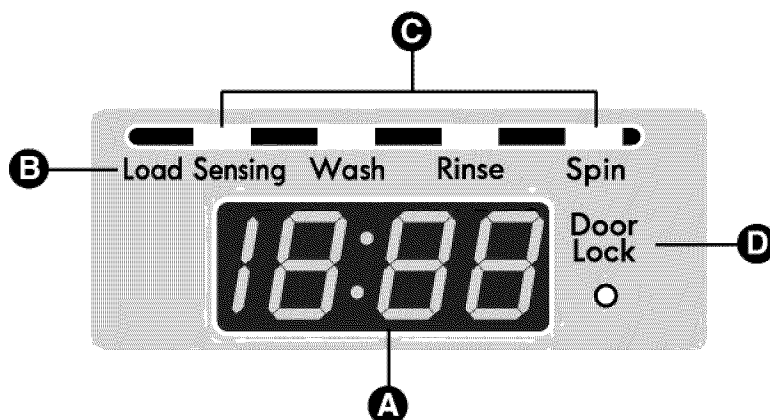

A ESTIMATED TIME REMAINING

When the START/PAUSE is pressed, the washer automatically detects the wash load (weight) and optimizes the washing time, based on the selected cycle and options. The display will then indicate the estimated time remaining for the selected wash cycle.

NOTE:

- The time shown is estimated. For example, the time displayed may pause for a period of time while the machine is heating the water or balancing the load. Under certain conditions, the machine can pause for extended periods of time.
- Estimated time is based on normal operating conditions. Several external factors (load size, room temperature, incoming water temperature, etc.) also affect the length of estimated time vs. actual time.

B LOAD-SENSING INDICATOR

This light will illuminate at the beginning of the cycle while the control measures the size of the load. Once the size has been determined, the control will adjust the cycle for optimum performance. Estimated time remaining will not be displayed until the load size has been determined and may be different for each load.

C CYCLE STATUS INDICATOR

These status LEDs illuminate to indicate which portion of the cycle is currently running. A blinking light indicates the active portion of the cycle. When that portion is complete, the light will remain steady.

D DOOR LOCK INDICATOR

Indicates that the door is locked. The washer door will lock while the washer is operating. The door can be unlocked by pressing the START/PAUSE to pause the washer.

NOTE:

- If the temperature in the washer is too high, the door cannot be unlocked until the washer has cooled.
- If the water level is too high, the door will not unlock. To drain the water, cycle the power off/on, then press the spin speed button without selecting a cycle. Press start and the water will be drained and the clothes will be spun out. Do not try to force the door open, as it will damage the door.

CYCLE MODIFIER BUTTONS

Each cycle has default settings that are selected automatically. You may also customize these settings using the cycle modifier buttons. Press the button for the desired modifier until the indicator light for the desired value is lit. The washer automatically adjusts the water level for the type and size of wash load for best results and maximum efficiency. Due to the high-efficiency nature of this product, water levels may be much lower than expected. This is normal operation and cleaning/rinsing performance will not be compromised.

NOTE: To protect your garments, not every wash/rinse temperature, spin speed, soil level, or option is available with every cycle. See the Cycle Guide on page 14 for details.

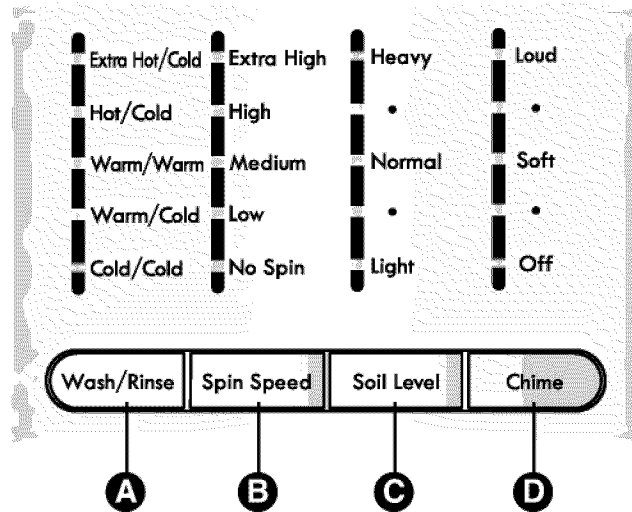

A WASH/RINSE

Selects the wash and rinse temperature combination for the selected cycle. Press the WASH/RINSE button until the indicator light for the desired setting is lit.

- Your washer features a heating element to boost the hot water temperature for Extra Hot settings. This provides improved wash performance at normal water heater settings.
- Select the water temperature suitable for the type of load you are washing. Follow the garment fabric care labels for best results.
- Warm rinses are regulated at approximately 86°F (30°C).
- Warm rinses leave the clothes drier than cold rinses, but will result in increased energy consumption and greater wrinkling of clothes.
- Cold rinses use less energy. The actual rinse temperature depends on the temperature of the cold water at the faucet.

B SPIN SPEED

This extracts more water from clothes, reducing drying time and saving energy.

Press the SPIN SPEED button until the indicator light for the desired setting is lit. Some fabrics, such as delicates, require a slower spin speed.

The Drain & Spin cycle:

1. Press the POWER button to turn on the washer.
2. Press the SPIN SPEED button to select the desired spin speed. For drain only, select the NO SPIN option.
3. Press the START/PAUSE button. The water will be drained and the clothes will be tumbled before the spin routine begins.

C SOIL LEVEL

Adjusts the selected cycle to allow more time for heavily soiled clothes or less time for lightly soiled clothes. Press the SOIL LEVEL button until the indicator light for the desired setting is lit.

D CHIME

Press repeatedly to adjust the volume of the chime. You may turn the end-of-cycle chime and keypad tones on or off with the CHIME button.

CYCLE OPTION BUTTONS

Your washing machine features several additional cycle options to customize cycles to meet your individual needs.

- 1 Turn on the washer and turn the cycle selector knob to select the desired cycle.
- 2 Use the cycle modifier buttons to adjust the settings for that cycle.
- 3 Press the cycle option button(s) for the option(s) you would like to add. The button will light when that option is selected.
If the selected option is not allowed for the selected cycle, the chime will sound twice to inform you that it is not allowed.
- 4 Press the START/PAUSE button to start the cycle. The washer will start automatically after a brief delay for locking the door.

NOTE: To protect your garments, not every option is available with every cycle. See the CYCLE GUIDE for details.

DELAY START



Delay Start

Once you have selected the cycle and other settings, press this button to delay the start of the wash cycle. Each press of the button increases the delay time by one hour, for up to 19 hours. Once the desired delay time is set, press the START/PAUSE button to start the delay time. If the START/PAUSE button is not pressed within 4 minutes, the control will shut off and the settings will be lost.

2nd RINSE



2nd Rinse

This option will add an extra rinse to the selected cycle. Use this option to help ensure the removal of detergent or bleach residue from fabrics.

STAIN TREAT



Stain Treat

Use this option for heavily soiled loads that need improved stain treatment. When STAIN TREAT is selected, the water temperature for the selected cycle will begin as warm water to help prevent the setting of certain types of stains. Then as the cycle progresses, the water will be heated to higher temperatures to help remove stains that require treatment at higher temperatures. This option is designed for optimum stain removal.

NOTE:

- If STAIN TREAT is selected with the SANITARY cycle, the cycle will begin with very hot water since that is default for that cycle and cannot be changed.

AUTO SOAK



Auto Soak

Use the AUTO SOAK option to presoak garments to help remove difficult spots or stains on fabrics. This option provides a 30 minute presoak prior to the start of the selected cycle.

- 1 Add detergent only to the Main wash compartment of the dispenser drawer. (See "Using the Dispenser" on pages 16-17.)
- 2 Select desired cycle.
- 3 Select cycle modifiers.
- 4 Press the START/PAUSE.

SPECIAL FUNCTIONS

CONTROL LOCK



Control Lock

Use this option to disable the controls. This feature allows you to prevent children from changing cycles or operating the machine. Once set, the CONTROL LOCK must be turned off before the controls can

be used. Once the washer has shut off, the power button will allow the machine to be turned on, but the controls will still be locked. When the controls are locked, "CL" will be displayed alternately with the estimated time remaining. Press and hold the CONTROL LOCK button for 5 seconds to activate or deactivate the controls.

To lock the controls without running a cycle, turn the washer on then press and hold the CONTROL LOCK button for 5 seconds. The controls will be locked, and the washer will power off after 4 minutes.

CLEAN WASHER



Clean Washer

A buildup of detergent residue can occur in the wash tub over time and can lead to a mildewy or musty smell. The CLEAN WASHER cycle is specially designed to remove this buildup using bleach or other cleaner designed specifically for cleaning front load washers. The CLEAN WASHER cycle should be run once a month, or more often under heavy use conditions or if odor is present.

- 1 Turn on the washer and press the CLEAN WASHER button. Selecting any other cycle after CLEAN WASHER has been selected will cause the CLEAN WASHER cycle to be cancelled.
- 2 Fill the bleach dispenser to the MAX line with liquid chlorine bleach*. Do not overfill the bleach dispenser. Overfilling will cause the bleach to be dispensed immediately.
- 3 Press the START/PAUSE to start the cycle.
- 4 After the cycle has ended, open the door and allow the drum interior to dry completely.

NOTE: Do NOT use this cycle with clothes, and do NOT add detergent or fabric softener.

* For powdered tub cleaners, add the cleaner to the main wash compartment of the dispenser drawer. Place tablet cleaners directly into the tub. Always follow the cleaner manufacturers instructions and recommendations

⚠ WARNING: To reduce the risk of fire, electric shock, or injury to persons, read and follow this entire manual, including the Important Safety Instructions, before operating this washer.

- **Unplug the washer before cleaning to avoid the risk of electric shock.** Failure to follow this warning can cause serious injury, fire, electrical shock, or death.
- **Never use harsh chemicals, abrasive cleaners, or solvents to clean the washer.** They will damage the finish.

REGULAR CLEANING

Cleaning the Exterior

Proper care of your washer can extend its life. The outside of the machine can be cleaned with warm water and a mild, non-abrasive household detergent.

Immediately wipe off any spills with a soft, damp cloth.

IMPORTANT: Do not use methylated spirits, solvents, or similar products. Never use steel wool or abrasive cleaners because they can damage the surface.

Care and Cleaning of the Interior

Use a towel or soft cloth to wipe around the washer door opening, door seal, and door glass. These areas should be kept clean to ensure a watertight seal. Be sure to wipe under the inside rubber seal to remove any moisture or soil.

Always remove items from the washer as soon as the cycle is completed. Leaving damp items in the washer can cause wrinkling, color transfer, and odor.

Run the CLEAN WASHER cycle once a month, or more often if needed, to remove detergent buildup and other residue.

Read these instructions carefully before beginning the CLEAN WASHER cycle.

- 1** Open the door and remove any clothing in the wash drum.
- 2** Open the dispenser drawer.
- 3** Add liquid chlorine bleach or tub cleaner.
Some powder or tablet tub cleaners which are manufactured for this purpose can be used.
(NOTE : Do not add any laundry detergent or fabric softener to the drawer when using CLEAN WASHER.)
- **If using liquid chlorine bleach**
Add liquid chlorine bleach to the bleach compartment of the drawer. (NOTE : Do not exceed the maximum fill line and do not pour undiluted liquid bleach directly into the wash drum.)
- **If using powder cleaner**
Remove the liquid detergent cup and add powder cleaner to the main wash compartment of the drawer.
- **If using tablet cleaner**
Add tablet cleaner to the wash drum directly.
(NOTE : Do not add tablet cleaner to the drawer.)
- 4** Close the drawer and washer door.
- 5** Select CLEAN WASHER and press START.

NOTE: It is recommended that CLEAN WASHER should be repeated monthly. If mildew or musty smell already exists, run CLEAN WASHER for 3 consecutive weeks. After CLEAN WASHER is complete or when the washer is not used, leave the washer door open for better ventilation and drying inside of the washer.

Door Seal and Glass Cleaning

Due to the location and nature of the door seal, some detergent and soil residue may build up on the door glass and seal.

Periodic cleaning with a bleach solution can help remove buildup and stains and can help sanitize the seal to prevent odors.

NOTE: Wear rubber gloves and eye protection while performing the following procedure:

- 1** Dilute 3/4 cup (177 ml) liquid chlorine bleach with 1 gallon (3.8 L) of warm/hot water.
- 2** Use this solution to wipe down all surfaces of the gasket and glass gasket to remove any deposits left there. (The gasket is stiff. Be sure to fold back the lip of the gasket to get under the edge where residue can build up.)
- 3** Wipe the gasket and glass with a dry cloth.
- 4** Leave the door open to allow the gasket to dry completely.

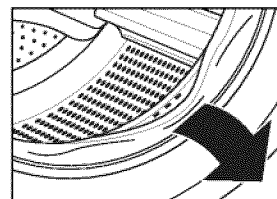

NOTE:

- Follow the manufacturer's instructions for proper use of bleach.
- Do not use undiluted bleach as this will damage the gasket.

Removing Mineral Buildup

If you live in an area with hard water, lime scale can form on internal components of the washer. Use of a water softener is recommended in areas with hard water.

Use a descaler, such as Washer MagicR, and run the CLEAN WASHER cycle before washing clothing.

Do NOT use steel wool or abrasive cleaners; they can damage the surface.

Storing the Washer

If the washer will not be used for an extended period of time and is in an area that could be exposed to freezing temperatures:

- 1** Turn off water supply tap.
- 2** Disconnect hoses from water supply and drain water from hoses.
- 3** Plug the power cord into a properly grounded electrical outlet.
- 4** Add 1 gallon of nontoxic recreational vehicle (RV) antifreeze to the empty wash drum. Close door.
- 5** Select the spin cycle and let washer spin for 1 minute to drain out all the water.
NOTE: Not all of the RV antifreeze will be expelled.
- 6** Unplug the power cord, dry the drum interior with a soft cloth, and close the door.
- 7** Remove the inserts from the dispenser. Drain any water in compartments and dry the compartments.
- 8** Store the washer in an upright position.
- 9** To remove the antifreeze from the washer after storage, run washer through a complete cycle using a small amount of detergent. Do not add laundry!

REGULAR CLEANING (cont.)

Cleaning the Dispenser

The dispenser should be cleaned periodically to remove buildup of detergent and other laundry products that can cause the dispenser not to dispense the laundry product properly.

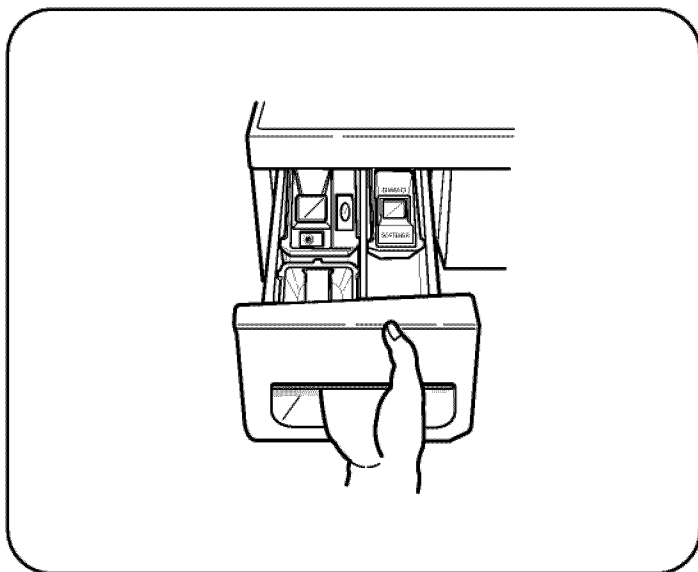

1. Pull the dispenser drawer out until it stops.

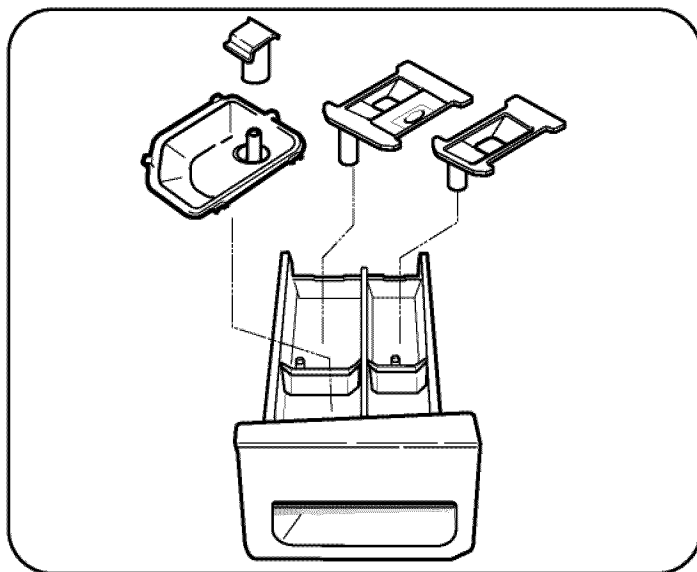

3. Remove the liquid detergent box, softener and bleach inserts from their compartments.

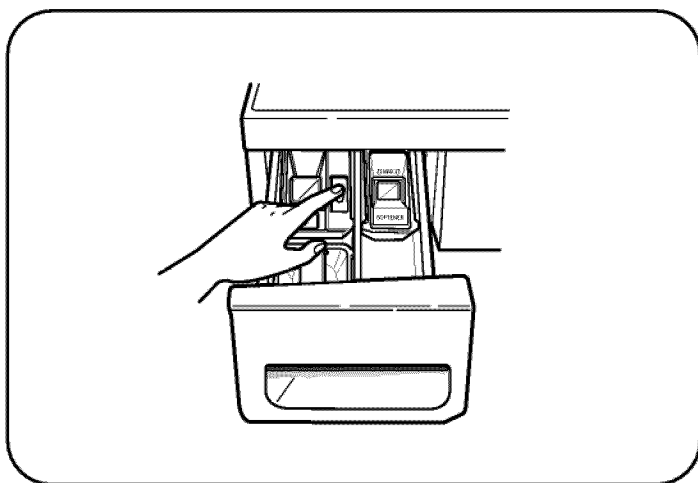

2. Press down the lock tab located between the bleach and softener compartments and slide the drawer out.

MAINTENANCE

Cleaning the Water Inlet Filters

If the washer detects that water is not entering the dispenser, an error message will show on the display. Inlet valve filter screens could be plugged by hard water scale, sediment in the water supply, plumbing scale, etc.

NOTE: The inlet screens protect the delicate parts of the fill valve from being damaged by particles that may get into the valves with the water supply. Operating the washer with the filters removed could cause a valve to fail open resulting in flooding and/or property damage.

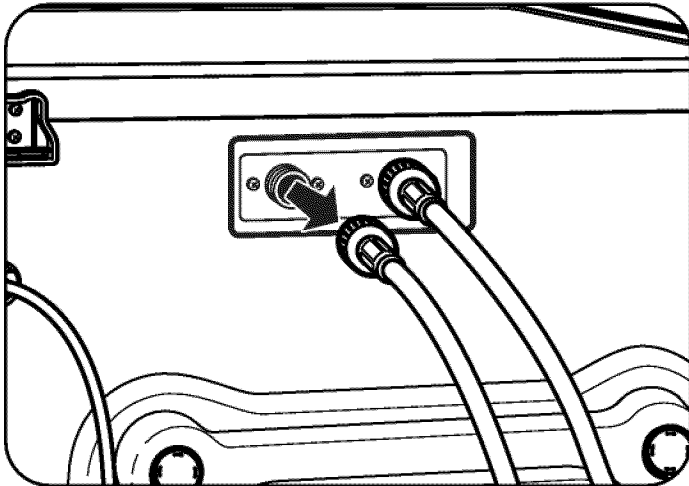

1. Turn off both water taps completely. Unscrew the hot and cold water lines from the back of the washer.

IMPORTANT: Use **ONLY** the inlet hoses provided with this laundry product. Aftermarket hoses are not guaranteed to fit or function correctly. Other hoses may not tighten correctly and could cause leaks. Subsequent damage to product or property will not be covered under the terms of the product warranty.

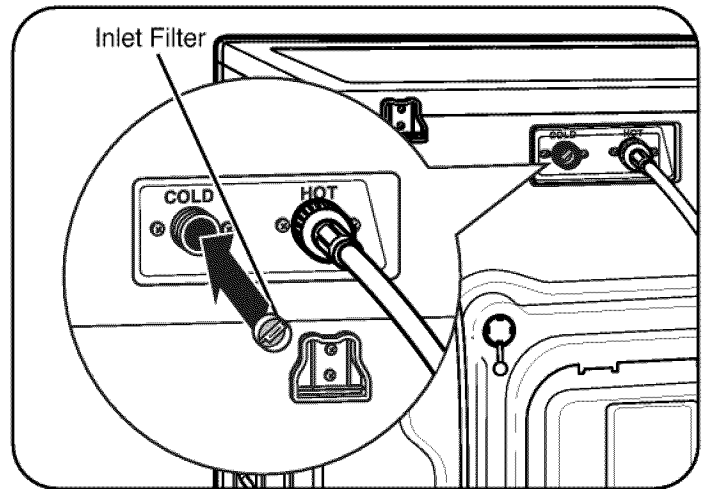

2. Carefully remove the filters from the water valves and soak them in white vinegar or a lime scale remover, following the manufacturer's instructions. Rinse thoroughly before reinstalling.

Press the filters back into place and reattach the water lines.

NOTE: The inlet screens protect the delicate parts of the fill valve from being damaged by particles that may get into the valves with the water supply. Operating the washer with the filters removed could cause a valve to fail open resulting in flooding and/or property damage.

MAINTENANCE (cont.)

Cleaning the Drain Pump Filter

Your Washer is equipped with a filter that helps prevent excess lint and foreign objects like buttons, keys, and coins from causing damage to the pump. If the washer fails to drain properly, unplug the washer and allow the water to cool, if necessary, before proceeding.

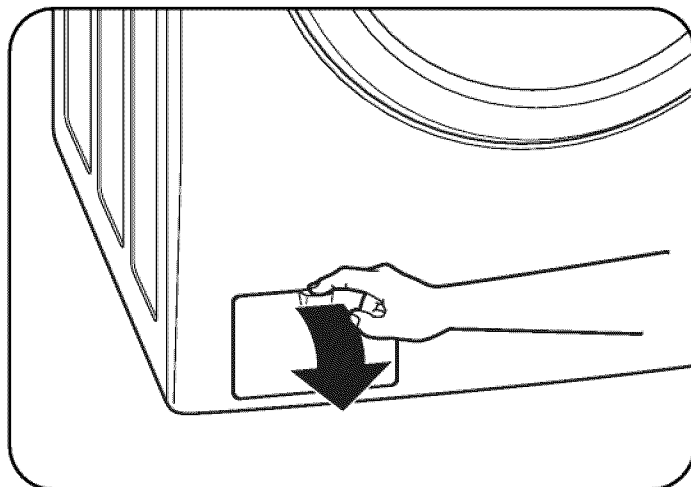

1. Open the drain pump filter access panel.

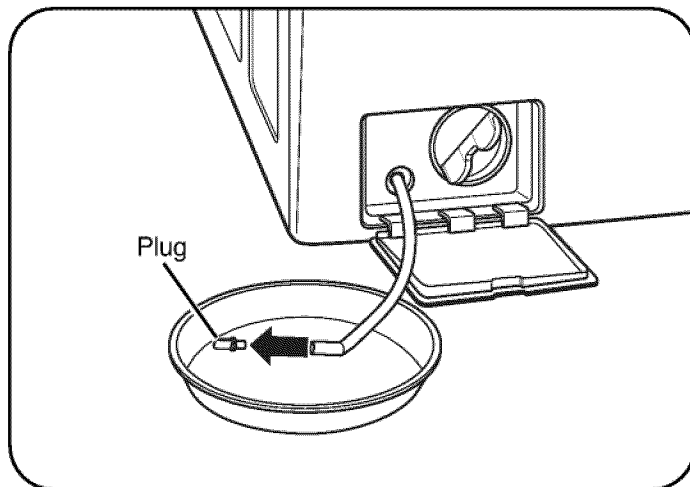

3. Remove the plug from the drain hose, and allow the water to drain completely.

NOTE: If there is a large amount of water in the tub, you may have to empty your container several times.

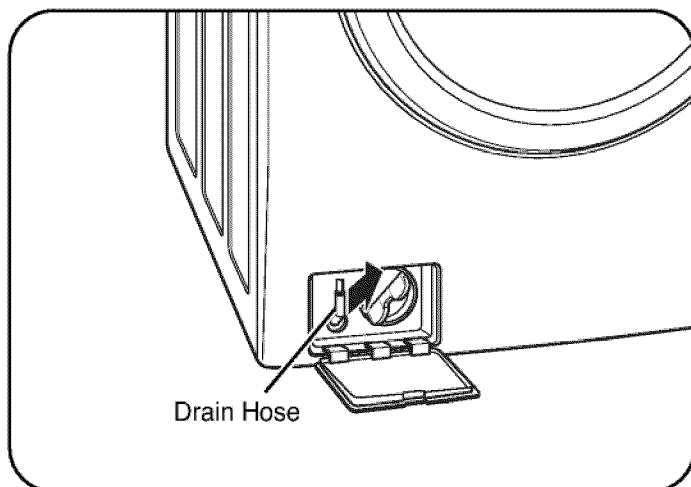

2. Unclip the drain hose and pull it out. Place the end of the drain hose into a shallow pan or a floor drain. Use care not to pull the hose out too far or it may not drain properly.

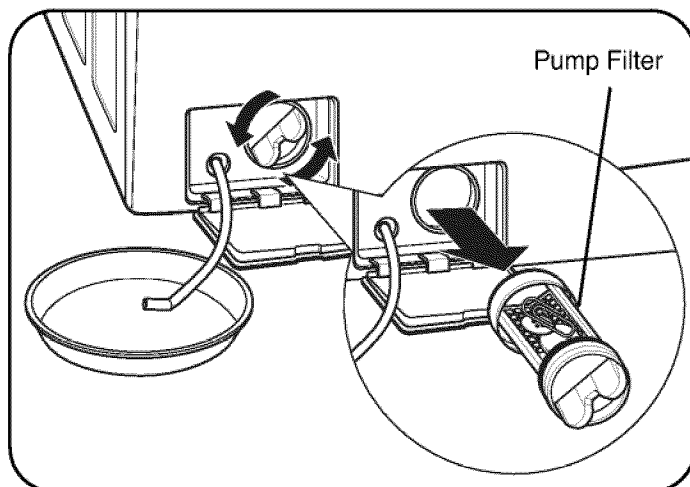

4. Twist the pump filter counterclockwise to remove. Remove any lint and foreign objects from the pump filter. Reverse the above steps to reinstall the drain pump filter and drain hose. Be sure to close the cover panel when finished.

TROUBLESHOOTING GUIDE

NORMAL SOUNDS YOU MAY HEAR

The following sounds may be heard while the washer is operating. They are normal.

Clicking:

Door lock relay when the door locks and unlocks.

Spraying or hissing:

Water spraying or circulating during the cycle.

Humming or gurgling:

Drain pump pumping water from the washer at the end of a cycle.

Splashing:

Clothes tumbling in the drum during the wash and rinse cycles.

BEFORE CALLING FOR SERVICE

Your washing machine is equipped with an automatic error-monitoring system to detect and diagnose problems at an early stage. If your washer does not function properly or does not function at all, check the following before you call for service.

Rattling and clanking noise

Check if...	Then...
Foreign objects, such as keys, coins, or safety pins, may be in drum or pump.	Stop washer and check drum and drain filter for foreign objects. If noise continues after washer is restarted, call for service.

Thumping sound

Check if...	Then...
Heavy wash loads may produce a thumping sound.	This is normal. If sound continues, washer is probably out of balance. Stop and redistribute wash load.
Washer load may be out of balance. Washing shoes or tightly tangled clothes.	Pause the cycle and redistribute the load after the door unlocks.

Vibrating noise

Check if...	Then...
Shipping bolts and/or packaging materials not removed.	See Unpacking and Removing Shipping Bolts in the Installation Requirements on page 8.
Wash load may be unevenly distributed in the drum.	Pause the cycle and redistribute the load after the door unlocks.
Not all leveling feet are resting firmly and evenly on the floor.	See Leveling the Washer in the Installation Instructions on page 11.
Floor not rigid enough.	Make sure that the floor is solid and does not flex. See Flooring in the Installation Requirements on page 7.

Water leaking around washer

Check if...	Then...
Fill hose connection is loose at tap or washer.	Check hoses. Check and tighten hose connections.
House drain pipes are clogged.	Unclog drain pipe. Contact a plumber if necessary.
Drain hose has come out of drain. Drain hose is not inserted far enough.	Tie drain hose to inlet hose or standpipe to prevent it from coming out during drain. It should be inserted about 8-12 inches into the standpipe.

Excessive sudsing

Check if...	Then...
Too much detergent or incorrect detergent.	 Only use detergent with the HE (High-Efficiency) logo. See Detergent Use in the How to Use section on page 16.

TROUBLESHOOTING GUIDE

BEFORE CALLING FOR SERVICE (cont.)

Staining

Check if...	Then...
Were bleach or softener added directly to the wash load in the drum?	Laundry chemicals must be loaded into the dispenser.
Washer not unloaded promptly.	Always remove items from the washer as soon as possible after the cycle is complete.
Clothes not properly sorted.	Always wash dark colors separately from light colors and whites to prevent discoloration. If possible, do not wash heavily soiled items with lightly soiled ones.

Water in the washer drains slowly or not at all, or the display shows: DE

Check if...	Then...
Drain hose is kinked, pinched, or clogged.	Make sure the drain hose is free of clogs, kinks, etc., and is not pinched behind or under the washer.
The drain filter is clogged.	Clean the drain filter. See <i>Maintenance</i> in the Care and Cleaning section on page 24.
Drain discharge is more than 96" above bottom of washer.	Adjust or repair drain.

Washer fills with water slowly or not at all, or the display shows: IE

Check if...	Then...
Water supply taps are not open fully.	Make sure that the water taps are open fully.
Water line hoses are kinked, pinched, or crushed.	Make sure the hoses are not kinked or pinched. Be careful when moving the washer.
Water inlet filters are clogged.	Clean the inlet filters. See <i>Maintenance</i> in the Care and Cleaning section on page 23.
Water pressure to tap or house is too low.	Check another faucet in the house to make sure that household water pressure is adequate.
Water supply connected with leak-limiting hoses.	Hoses designed to limit leaks if a hose fails can trip falsely and prevent washer from filling.

Washer will not turn on

Check if...	Then...
Power cord is not properly plugged in.	Make sure that the plug is plugged securely into a grounded, 3-prong, 120-VAC, 60-Hz. outlet.
House fuse is blown, circuit breaker has tripped, or power outage has occurred.	Reset circuit breaker or replace fuse. Do not increase fuse capacity. If the problem is a circuit overload, have it corrected by a qualified electrician.

Cycle won't start, or the display shows: dE

Check if...	Then...
The door is not closed properly.	Make sure that the door is closed properly and press the START/PAUSE button. After starting a cycle, it may take a few moments before the drum begins to turn or spin. The washer will not operate unless the door is locked.
	If the door is closed and locked and the open door error message is displayed, call for service.

TROUBLESHOOTING GUIDE

BEFORE CALLING FOR SERVICE (cont.)

Door will not unlock when cycle is stopped or paused

Check if...	Then...
Interior temperature of washer is too high.	The washer door has a safety feature to prevent burns. For example, if the washer is paused during the hot wash portion of a sanitary cycle, the interior temperature of the drum will be very hot, so the door will not unlock. This is normal. Allow the washer to cool until the DOOR LOCK indicator turns off on the display.
Water level in washer is too high.	Allow the washer to complete the programmed cycle, or press the CANCEL/DRAIN button to drain the water.

Wash cycle time is longer than usual

Check if...	Then...
The washer automatically adjusts the wash time for the amount of laundry, water pressure, water heating time, and other operating conditions.	This is normal. The washer adjusts cycle time automatically to provide optimal results for the selected cycle. The time remaining shown in the display is only an estimate. Actual time may vary.

Musty or mildewy odor in washer

Check if...	Then...
Incorrect or too much detergent has been used.	Use only HE (High-Efficiency) detergent in accordance with the manufacturer's instructions.
Inside of tub not cleaned properly.	Run the CLEAN WASHER cycle regularly. Be sure to wipe around and under the door seal frequently. See Care and Cleaning of the Interior in Care and Cleaning on page 21.
	Clean around door seal/glass to prevent odor or mildew: <ol style="list-style-type: none"> 1. Wipe dry the door seal/glass and the door opening area. 2. Wipe around the inner drum/door seal and the lower door seal. 3. For difficult-to-remove odors, use Affresh available at your local Sears store or online at www.partsdirect.com.

Wrinkling

Check if...	Then...
Washer not unloaded promptly.	Always remove items from the washer as soon as the cycle is complete.
Washer overloaded.	The washer can be fully loaded but the drum should not be tightly packed, and the door should close easily.
Hot and cold water inlet hoses are reversed.	Hot water rinse can set wrinkles in garments. Check the inlet hose connections.

TROUBLESHOOTING GUIDE

BEFORE CALLING FOR SERVICE (cont.)

The display shows: **UE**

Check if...

Then...

Load is too small.	Add 1 or 2 similar items to help balance the load.
Load is out of balance.	Pause the cycle and redistribute the load after the door unlocks.
	The washer has an imbalance detection and correction system. If individual heavy articles are loaded (bath mat, bath robe, etc.) and the imbalance is too great, the washer will make several attempts to restart the spin cycle. If an imbalance is still detected, the washer will stop and the error code will be displayed.

The display shows: **EE**

Check if...

Then...

Control error.	Unplug the washer and wait 60 seconds. Reconnect power and try again. If the error reappears, call for service.
----------------	---

The display shows: **FE**

Check if...

Then...

Water level is too high due to a faulty water valve.	Close the water taps, unplug the washer, and call for service.
--	--

The display shows: **PE**

Check if...

Then...

The water level sensor is not working correctly.	Close the water taps, unplug the washer, and call for service.
--	--

The display shows: **LE**

Check if...

Then...

Thermal overload protection circuit in the motor has been tripped.	Allow the washer to stand for 30 minutes to allow the motor to cool; then restart the cycle. If the LE error code persists, call for service.
--	---

The display shows: **PF**

Check if...

Then...

A power failure has occurred.	If the power to the washer has been interrupted during a cycle, the "PF" error code will be displayed the next time the washer is turned on. This will alert you to the fact that the previous cycle may not have been completed. Select any cycle to clear the error code and use the washer.
-------------------------------	--

One-Year Limited Warranty

When installed, operated and maintained according to all instructions supplied with the product, if this appliance fails due to a defect in material and workmanship within one year from the date of purchase, call 1-800-4-MY-HOME® to arrange for free repair.

If this appliance is ever used for other than private family purposes, this warranty applies for only 90 days from the date of purchase.

This warranty covers only defects in material and workmanship. Sears will NOT pay for:

1. Expendable items that can wear out from normal use, including but not limited to filters, belts, light bulbs, and bags.
2. A service technician to instruct the user in correct product installation, operation or maintenance.
3. A service technician to clean or maintain this product.
4. Damage to or failure of this product if it is not installed, operated or maintained according to all the instructions supplied with the product.
5. Damage to or failure of this product resulting from accident, abuse, misuse or use for other than its intended purpose.
6. Damage to or failure of this product caused by the use of detergents, cleaners, chemicals or utensils other than those recommended in all instructions supplied with the product.
7. Damage to or failure of parts or systems resulting from unauthorized modifications made to this product.

Disclaimer of Implied warranties; limitation of remedies

Customer's sole and exclusive remedy under this limited warranty shall be product repair as provided herein. Implied warranties, including warranties of merchantability or fitness for a particular purpose, are limited to one year or the shortest period allowed by law. Sears shall not be liable for incidental or consequential damages. Some states and provinces do not allow the exclusion or limitation of incidental or consequential damages, or limitation on the duration of implied warranties of merchantability or fitness, so these exclusions or limitations may not apply to you.

This warranty applies only while this appliance is used in the United States or Canada.

This warranty gives you specific legal rights, and you may also have other rights which vary from state to state.

Limited 10-Year Warranty on Direct Drive Motor- For the second through tenth year from the date of purchase, Sears will replace the Direct Drive Motor if it is defective in material or workmanship. After your first year, you will be charged for labor.

Sears Brands Management Corporation, Hoffman Estates, IL 60179
Sears Canada Inc., Toronto, Ontario, Canada M5B 2B8